

SECTION - 3

ENCLOSURES TO THE SPECIFICATION

- 1 PGCIL Technical Specification, Section: Civil Works (C/ENGG/SPEC/CIVIL/ Rev No.: 07)**
- 2 PGCIL Standard Field Quality Plan for Switchyard Civil Works**
- 3 PGCIL Drawings (As per attached "List of Drawings")**

SECTION: CIVIL

1.0 GENERAL

The intent of this technical specification covers the following:

Construction of all civil works at sub-station is covered in the scope of contract as per drawings supplied by Owner.

All civil works shall be carried out as per design/drawings standardised by the Owner and these specification provided by the Owner. All standard drawings are enclosed with the tender documents. In case any item is not covered under specification then the same shall be carried out as per CPWD specification and applicable Standards and Codes. Any item for which specification is not provided herein and is not covered under CPWD specification shall be executed as per manufacturer guidelines. All materials shall be of best quality conforming to relevant Indian Standards and Codes. In case of any conflict between Standards/ Code and Technical Specification, the provisions of Technical Specification shall prevail.

The Contractor shall furnish all labour, tools, equipment, materials, temporary works, constructional plant and machinery, fuel supply, transportation and all other incidental items not shown or specified but as may be required for complete performance of the Works in accordance with drawings, specifications and direction of Owner.

All materials including cement, reinforcement steel and structural steel etc. shall be arranged by the Contractor. All testing required shall be arranged by the Contractor at his own cost. The contractor shall execute the work as per the Field Quality Plan (FQP) attached with this document.

The bidder shall fully appraise himself of the prevailing conditions at the proposed site. Climatic conditions including monsoon patterns, local conditions and site specific parameters and shall include for all such conditions and contingent measures in the bid, including those which may not have been specifically brought out in the specifications.

2.0 Drawings

Standard drawings have been developed by the Owner, as mentioned below, and are enclosed with the tender documents. The drawings enclosed with the tender are good for construction. However, after the award, 4 sets of these drawings, with a released for construction stamp, shall be issued by the Owner to the Contractor matching with the requirement at Site or the contractor may be advised to follow tender drawings. The Contractor shall execute the work at Site as per these

drawings only.

Drawings that have been mentioned to be issued by the Owner to the Contractor during detailed Engineering shall be made available to the Contractor as per the agreed work schedule finalised after award. Also, further details required, if any, to complete the work in totality, shall be made available to the Contractor as per the agreed work schedule finalised after award.

2.1 Control room building

All construction drawings are enclosed with the tender documents.

2.2 Fire fighting pump house building and fire water tank

All construction drawings are enclosed with the tender documents.

2.3 Tower & equipment foundations

All construction drawings for towers and equipments foundations are enclosed with the tender documents.

Drawings for any non-standard tower or equipment foundation, if required, shall be designed by the Owner and made available to the Contractor during detailed Engineering. Foundations for any miscellaneous requirements like electric poles, marshalling box, control cubicles, etc. shall be engineered by the Contractor and the design and drawings shall be submitted for owner's approval.

Drawings for transformer, reactor foundations and fire wall are not enclosed and shall be made available to the contractor by the owner during detailed engineering.

In case the site conditions warrant any special type of foundations to be used, the same shall be designed and issued by the owner to the contractor during detailed engineering.

2.4 Township Works

The Construction drawings of all the residential and non-residential buildings i.e. B-1, B-2, B-3, C & D type Quarters, transit camp, recreation centre, covered parking are enclosed herewith with the tender documents. Layout of the township shall be issued to the Contractor by the site.

2.5 Roads and rail cum Road

The construction drawings showing section detail for road as well as rail cum road is enclosed with the tender documents.

2.6 Drains

The construction drawing for the *section of* drain is enclosed with the tender documents. The contractor shall develop an overall drainage layout for the new sub-station/ extension of substation during detailed engineering. The type of drains used shall be of the sections standardized and indicated in the drawings enclosed with the tender documents.

2.7 Under Ground Water Tank

The construction drawing for the under ground water tank and pump house for water supply to township have been provided in the tender document. The scope also includes supplying and erection of 2 numbers ISI marked centrifugal water pump (Monoblock) at 415 Voltage 3 phase 50 cycle/per second of 7.5 HP along with all necessary accessories.

2.8 External Sewage System of Township

The drawing for the Sewage system consisting of glazed stoneware pipes Grade-A with all round cement grade 1:5:10 including manholes, road crossing, gali trap connections etc for connecting each fittings with the septic tank shall be developed by the Contractor and submitted to Engineer-in-Charge for approval before execution. Manholes of suitable size as per CPWD standard design and depth shall be provided at all turning points and junction with spacing between 2 manholes not exceeding 30m. Heavy duty covers shall be provided for the manholes in case it comes on the road.

2.9 Chain link fencing and gate

The construction drawings are enclosed with the tender documents.

2.10 Rain-water harvesting

The construction drawings are enclosed with the tender documents.

2.11 External water supply from bore-well to fire water tank

The drawing for the water supply from bore-well to fire water tank shall be developed by the contractor and submitted to owner for approval. Water supply will be made available to the Contractor from a bore-well by the Owner at any one location within the sub-station. 80 mm dia GI pipe shall be provided by the Contractor from the bore-well to the fire water tank. From this a 25 mm dia tap off shall be connected by the Contractor to the roof water tank provided for the control room building.

2.12 Septic tank and soak pit

The construction drawings are enclosed with the tender documents.

2.12 Stone spreading and antiweed treatment

The layout of the area where anti-weed treatment and stone spreading is to be provided shall be made available to the contractor during detailed engineering.

3.0 SITE PREPARATION:

Levelled/sloped site shall be handed over to the contractor. The finished ground level (FGL) shall be the finished formation level furnished by the owner. The layout and levels of all structure etc shall be made by the Contractor at his own cost from the general grids of the plot and benchmarks set by the Contractor and approved by the Owner. The Contractor shall provide all assistance in instruments, materials and personnel to the Owner for checking the detailed layout and shall be solely responsible for the correctness of the layout and levels.

3.1 SCOPE

This clause covers the execution of the work for site preparation, such as clearing of the site, the supply and compaction of fill material, excavation and compaction of backfill for foundation, road construction, drainage, trenches and final topping by stone (broken hard stone).

3.2 GENERAL

- 1) Material unsuitable for founding of foundations shall be removed and replaced by suitable fill material and to be approved by the Owner.
- 2) Backfill material around foundations or other works shall be suitable for the purpose for which it is used and compacted to the density described under Compaction. Excavated material not suitable or not required for backfill, shall be disposed off in area's as directed

by Owner up to a maximum lead of 2 km.

3.3 EXCAVATION AND BACKFILL

1. Excavation and backfill for foundations shall be in accordance with the relevant code.
2. Whenever water table is met during the excavation, it shall be dewatered and water table shall be maintained below the bottom of the excavation level during excavation, concreting and backfilling.
3. Embankments adjacent to abutments, culverts, retaining walls and similar structures shall be constructed by compacting the material in successive uniform horizontal layers not exceeding 20 cm in thickness. (of loose material before compaction). Each layer shall be compacted as required by means of mechanical tampers approved by the Owner. Rocks larger than 10 cm in any direction shall not be placed in embankment adjacent to structures.
4. Earth embankments of roadways and site areas adjacent to buildings shall be placed in successive uniform horizontal layers not exceeding 20 cm in thickness in loose stage measurement and compacted to the full width specified. The upper surface of the embankment shall be shaped so as to provide complete drainage of surface water at all times.

3.4 COMPACTION

1. The density to which fill materials shall be compacted shall be as per relevant IS and as per direction of Owner. All compacted sand filling shall be confined as far as practicable. Backfilled earth shall be compacted to minimum 95% of the Standard Proctor's density at OMC. The subgrade for the roads and embankment filling shall be compacted to minimum 95% of the Standard Proctor's density at OMC. Cohesion less material subgrade shall be compacted to 70% relative density (minimum).
2. At all times unfinished construction shall have adequate drainage. Upon completion of the road's surface course, adjacent shoulders shall be given a final shaping, true alignment and grade.
3. Each layer of earth embankment when compacted shall be as close to optimum moisture content as practicable. Embankment material which does not contain sufficient moisture to obtain proper compaction shall be wetted. If the material contains any excess moisture, then it shall be allowed to dry before rolling. The rolling

shall begin at the edges overlapping half the width of the roller each time and progress to the center of the road or towards the building as applicable. Rolling will also be required on rockfills. No compaction shall be carried out in rainy weather.

3.5 REQUIREMENT FOR FILL MATERIAL UNDER FOUNDATION

The thickness of fill material under the foundations shall be such that the maximum pressure from the footing, transferred through the fill material and distributed onto the original undisturbed soil will not exceed the allowable soil bearing pressure of the original undisturbed soil. For expansive soils the fill materials and other protections etc. to be used under the foundation is to be got approved by the Owner.

4.0 ANTIWEED TREATMENT & STONE SPREADING

4.1 SCOPE OF WORK

The Contractor shall furnish all labour, equipment and materials required for complete performance of the work in accordance with the drawings, specification and direction of the Owner.

Stone spreading along with cement concrete layer shall be done in the areas of the switchyard under present scope of work. However the stone spreading along with cement concrete layer in future areas within fenced area shall also be provided in case step potential without stone layer is not well within safe limits.

4.2 GENERAL REQUIREMENT

The material required for site surfacing/stone filling shall be free from all types of organic materials and shall be of standard quality, and as approved by the Owner.

4.2.1 The material to be used for stone filling/site surfacing shall be uncrushed/crushed/broken stone of 40mm nominal size (ungraded single size) conforming to Table 2 of IS:383 – 1970. Hardness, flakiness shall be as required for wearing courses are given below :

- (a) Sieve Analysis limits (Gradation)
(IS : 383 – Table – 2)

Sieve Size	% passing by weight
63mm	100
40mm	85-100

20mm 0-20

10mm 0-5

“One Test” shall be conducted for every 500 cu.m.

(b) Hardness

Abrasion value (IS:2386 Part-IV) – not more than 40%

Impact value (IS:2386 Part-IV) – not more than 30% and frequency shall be one test per 500 cu.m. with a minimum of one test per source.

(c) Flakiness Index

One test shall be conducted per 500 cu.m. of aggregate as per IS:2386 Part – I and maximum value is 25%.

4.2.2 After all the structures/equipments are erected, antiweed treatment shall be applied in the switchyard where ever stone spreading along with cement concrete is to be done and the area shall be thoroughly de-weeded including removal of roots. The recommendation of local agriculture or horticulture department may be sought where ever feasible while choosing the type of chemical to be used. The antiweed chemical shall be procured from reputed manufacturers. The doses and application of chemical shall be strictly done as per manufacturer’s recommendation. Nevertheless the effectiveness of the chemical shall be demonstrated by the contractor in a test area of 10MX10M (appx) and shall be sprinkled with water at least once in the afternoon everyday after forty eight hours of application of chemical. The treated area shall be monitored over a period of two to three weeks for any growth of weeds by the Engineer – in- charge. The final approval shall be given by Engineer – in –charge based on the results.

4.2.3 Engineer-in-charge shall decide final formation level so as to ensure that the site appears uniform devoid of undulations. The final formation level shall however be very close to the formation level indicated in the approved drawing.

4.2.4 After antiweed treatment is complete, the surface of the switchyard area shall be maintained, rolled/compacted to the lines and grades as decided by Engineer-in-charge. The sub grade shall be consolidated by using half ton roller with suitable water sprinkling arrangement to form a smooth and compact surface. The roller shall run over the sub grade till the soil is evenly and densely consolidated and behaves as an elastic mass.

4.2.5 In areas that are considered by the Engineer-in-Charge to be too congested with foundations and structures for proper rolling of the site surfacing material by normal rolling equipments, the material shall be compacted by hand, if

necessary. Due care shall be exercised so as not to damage any foundation structures or equipment during rolling compaction.

- 4.2.6 The sub grade shall be in moist condition at the time the cement concrete is placed. If necessary, it should be saturated with water for not less than 6 hours but not exceeding 20 hours before placing of cement concrete. If it becomes dry prior to the actual placing of cement concrete, it shall be sprinkled with water and it shall be ensured that no pools of water or soft patches are formed on the surface.
- 4.2.7 Over the prepared sub grade, 75mm thick base layer of cement concrete in 1:5:10 (1 cement :5 fine/coarse sand : 10 burnt brick aggregate. shall be provided in the area excluding roads, drains, cable trenches as per detailed engineering drawing. For easy drainage of water, the slope of 1:1000 is to be provided from the ridge to the nearest drain. The ridge shall be suitably located at the centre of the area between the nearest drains. The above slope shall be provided at the top of base layer of cement concrete in 1:5:10. A layer of cement slurry of mix 1:6 (1 cement : 6 fine sand) shall be laid uniformly over cement concrete layer. The cement consumption for cement slurry shall not be less than 150 kg. Per 100 sq.m.
- 4.2.8 A final layer of 100mm thickness of uncrushed/crushed/broken stone of 40 nominal size (ungraded size) shall be spread uniformly over cement concrete layer after curing is complete.

5.0 RAINWATER HARVESTING:

- 5.1 In addition to drainage of rainwater, the contractor shall make arrangement for rainwater harvesting also.
- 5.2 Rainwater harvesting shall be done by providing two numbers recharge structures with bore wells. The recharge structures shall be suitably located within the sub-station. Branch drains from the main drain carrying rainwater from entire switchyard shall be connected to the recharge structures.
- 5.3 The internal diameter of recharge shafts shall be 4.5 meter with 230mm thick lining of brick work upto a depth of 2.0 meter from ground level and 345mm thick brickwork below 2.0 meter depth. The brickwork shall be constructed with cement mortar 1:6 (1 cement : 6 coarse sand). The overall depth of shaft shall be 5.0 meter below invert level of drain. The shaft shall be covered with RCC slab for a live load of 300 kg. per sq.m. Two openings of size 0.7 x 0.7 meter shall be provided in the RCC cover slab as shown in the drawing. An iron cover made of 5mm thick chequered plate with hinges shall be provided on the openings. Galvanized M.S. rungs of 20mm diameter at spacing of 300 mm shall be provided in the wall of shaft below the opening in the RCC slab to facilitate cleaning of shaft.

5.4 A 300 mm diameter bore well shall be drilled in the centre of the shaft. The depth of bore well shall be 5.0 meter more than the depth of sub soil water.

5.5 A 100 mm dia medium duty MS pipe conforming to IS 1161 shall be lowered in the bore well keeping bail plug towards bottom of bore well. The pipe shall have 1.58mm holes for 4.0 meter length starting from 1.0 meter from bottom of bore well. Holes of 3.0mm dia shall be provided for a length of 2.0 meter starting from the bottom level of coarse sand and down wards. The overall length of pipe shall be equal to total depth of bore well plus depth of shaft.

5.6 Gravel of size 3mm to 6mm shall be filled around 100 dia MS pipe in the borewell. The shaft shall be filled with 500 mm thick layers each from the bottom of shaft with boulders of size 50mm to 150mm, gravel of size 5mm to 10mm, coarse sand having particle size 1.5mm to 2.0mm and boulders of size not less than 200mm respectively.

A drawing showing details of recharge structure for rainwater harvesting is enclosed.

6.0 ROADS AND CULVERTS

6.1 All the roads in the scope of contract shall be of concrete road.

6.2 There would be two types of Roads. The wider road shall be 5.5m wide and the other road shall be 3.75m wide.

The road outside the switchyard fenced area shall have shoulder of 1.75m in case of 5.5m wide road and 1.3 m in case of 3.75m wide road with kerb stone at the two side ends of the road. Interlocking tiles shall be laid on this shoulder. Kerb stone with channel are to be provided at both the side of the roads. The kerb stone on both side of the roads shall be painted yellow and black alternatively.

In case of switchyard road the shoulder would be compacted earth 600mm wide on the sides of both types of road.

6.3 Layout of the roads shall be as shown in the General Arrangement drawing for the substation issued along with the tender documents. Adequate turning space for vehicles shall be provided and bend radii shall be set accordingly. Road to the Autotransformer/Reactor shall be as short and straight as possible.

6.4 The road shall have 100mm thick RCC (1:1.5:3 nominal mix with reinforcement of 8mm dia. 300 C/C bothways) on the top. Below it 100mm thick PCC (1:4:8) shall be provided. 300mm thick water bound macadam (WBM) in three equal layers of 100mm each at the bottom.

PCC and WBM shall extend upto the shoulder width on both sides of the road outside switchyard area as per the drawing. In case of road within the switchyard PCC and WBM shall placed only upto the width of the road. Polythene sheet of 125 microns shall be placed between the RCC and PCC slab. Expansion joint (12mm thick) shall be provided at every 8.0 m. In addition, in case of 5.5 m wide road, expansion joint shall also be provided longitudinally at the center. 100mm dia RCC hume pipe (NP-3) shall be provided at every 100m interval across the length of the road for cable crossing.

The concrete shall be laid and finished with screed board, vibration, vacuum dewatering process and finishing by floating brooming with wire brush etc.

6.5 The details are furnished in the drawing enclosed with tender document.

6.6 The shoulder of the road in case of extension shall match with the shoulder of the existing road.

7.0 FOUNDATION /RCC CONSTRUCTION

7.1 GENERAL

1. Work covered under this Clause of the Specification comprises the construction of foundations and other RCC constructions for switchyard structures, equipment supports, trenches, drains, jacking pad, pulling block, control cubicles, bus supports, Autotransformer/Reactors, marshalling kiosks, auxiliary equipments & systems buildings, tanks or for any other equipment or service and any other foundation required to complete the work. This clause is as well applicable to the other RCC constructions.
2. Concrete shall conform to the requirements mentioned in IS:456 and all the tests shall be conducted as per relevant Indian Standard Codes as mentioned in Standard field quality plan appended with the specification. However, a minimum grade of M20 concrete (1: 1.5: 3 nominal volumetric mix) shall be used for all structural/load bearing members
3. If the site is sloping, the foundation height will be adjusted to maintain the exact level of the top of structures to compensate such slopes.

The switchyard foundation's plinths and building plinths shall be minimum 300mm and 500mm above finished ground level respectively.

5. Minimum 75mm thick lean concrete (1:4:8) shall be provided below all

~~and firewalls. In case of space constraints, these dimensions can be reduced as per the approval of owner.~~

~~The building walls, which act as firewalls, shall extend at least 1 m above the roof in order to protect it.~~

~~The firewall will be made of reinforced concrete (1:1.5:3 nominal mix).~~

7.3 ADMIXTURES & ADDITIVES

1. Only approved admixtures shall be used in the concrete for the Works. When more than one admixture is to be used, each admixture shall be batched in its own batch and added to the mixing water separately before discharging into the mixer. Admixtures shall be delivered in suitably labelled containers to enable identification.
2. Admixtures in concrete shall conform to IS:9103. The water proofing cement additives shall conform to IS:2645. Concrete Admixtures/ Additives shall be approved by Owner.
3. The Contractor may propose and the Owner may approve the use of a water-reducing set-retarding admixture in some of the concrete. The use of such an admixture will not be approved to overcome problems associated with inadequate concrete plant capacity or improperly planned placing operations and shall only be approved as an aid to overcoming unusual circumstances and placing conditions.
4. The water-reducing set-retarding admixture shall be an approved brand of Ligno-sulphonate type admixture.
5. The water proofing cement additives shall be used as required/ advised by the Owner.

8.0 Chainlink Fencing and Gate:

Fencing and Gate shall be provided at the locations shown in approved general arrangement drawing. Separate gate shall be provided for men and equipment. Fence shall also be provided for the various equipments (if) mounted on ground or a height lower than 2.5m. Necessary gates shall be provided for each area so surrounded. Fencing shall be constructed as per drawing attached with tender documents.

Chain link galvanised fence fabric with 3.15mm dia wire and 75mm mesh size conforming to IS: 2721 shall be used. MS tube used shall be of grade YST22 and conform to IS: 1161. All other structural steel shall conform to IS: 2062.

The whole assembly of tubular post shall be hot dip galvanized. The zinc coating shall be minimum 610 gram per sq. meter. The purity of zinc shall be 99.95% as per IS: 209. Frame of panels of chain link fencing shall be painted with two or more coats of approved standard synthetic enamel paint over approved standard steel primer.

The gate shall be made of medium duty M.S. pipe with welded joints. The main frame (outer frame) of the gate shall be made of 40mm dia pipe and vertical pipes of 15mm dia @ 125mm spacing (maximum) shall be welded with the main frame. Gate shall be painted with one coat of approved steel primer and two or more coats of synthetic enamel paint to give an even shade.

The height of the fencing shall be 1500mm on a toe wall of 300mm. Other details shall be as shown in the drawing.

9.0 WATER SUPPLY (EXTERNAL)

- (i) Water shall be made available by Owner (unless stated otherwise elsewhere) at any feasible point near scope boundary at single point to the contractor. Contractor shall state the total water requirement both in terms of quantity and head to the Owner.
- (ii) The contractor shall carry out all the external plumbing/erection works required for supply of water to the control room building beyond the single point as at (i).
- (iii) The contractor shall carry out all the plumbing/erection works required for supply of water to fire water tank beyond the single point as at (i).
- (v) A scheme shall be prepared by the contractor indicating the layout and details of water supply which shall be got approved from the Owner before actual start of work including all other incidental items not shown or specified but as may be required for complete performance of the works.
- (vi) Bore well is not in the scope of contractor.

10.0 TECHNICAL DETAILS OF THE BUILDINGS

- 12.0 MISCELLANEOUS GENERAL REQUIREMENTS**
- 12.1 Dense concrete with controlled water cement ratio as per IS-code shall be used for all underground concrete structures such as pump-house, tanks, water retaining structures, cable and pipe trenches etc. for achieving water-tightness.
- 12.2 All joints including construction and expansion joints for the water retaining structures shall be made water tight by using PVC ribbed water stops with central bulb. However, kicker type (externally placed) PVC water stops shall be used for the base slab and in other areas where it is required to facilitate concreting. The minimum thickness of PVC water stops shall be 5 mm and minimum width shall be 230 mm.
- 12.3 All mild steel parts used in the water retaining structures shall be hot-double dip galvanised. The minimum coating of the zinc shall be 750 gm/sq. m. for galvanised structures and shall comply with IS:2629 and IS:2633. Galvanizing shall be checked and tested in accordance with IS: 2633. The galvanizing shall be followed by the application of an etching primer and dipping in black bitumen in accordance with BS: 3416.
- 12.4 FPS Bricks of clay/ fly ash having minimum 75 kg/cm² compressive strength can only be used for masonry work. Contractor shall ascertain himself at site regarding the availability of bricks of minimum 75 kg/cm² compressive strength before submitting his offer.
- 12.5 Angles 50x50x5 mm (minimum) with lugs shall be provided for edge protection all round cut outs/openings in floor slab, edges of drains supporting grating covers, edges of RCC cable/pipe trenches supporting covers, edges of manholes supporting covers, supporting edges of manhole precast cover and any other place where breakage of corners of concrete is expected.
- 12.6 Anti termite chemical treatment shall be given to column pits, wall trenches, foundations of buildings, filling below the floors etc. as per IS: 6313 and other relevant Indian Standards.
- 12.7 The protections required to be carried out for aggressive alkaline soil, black cotton soil or any other type of soil which is detrimental/harmful to the concrete foundations shall be payable separately if the same is not covered in BPS.

- 12.8 For all civil works covered under this specification, nominal mix by volume batching as per CPWD specification is intended. The relationship of grade of concrete and ratio of ingredients shall be as below :

S.No.	Mix	Cement	Sand	Coarse aggregate of 20 mm down grade as per IS 383
1.	M 10	1	3	6
2.	M 15	1	2	4
3.	M 20	1	1.5	3

The material specification, workmanship and acceptance criteria shall be as per approved standard Field Quality Plan attached with this document. In case certain item is not covered in FQP, it shall be constructed as per CPWD specification..

- 12.9 Ready mix concrete pertaining to M20 grade of reputed manufacturer such as Lafarge, ACC, Ultra Tech, RMC Readymix India etc. or manufacturer of similar repute shall also be accepted for use in construction activity. Materials specification, workmanship and acceptance criteria of readymix concrete shall be as per IS-456.
- 12.10 Items/components of buildings not explicitly covered in the specification but required for completion of the project shall be deemed to be included in the scope.

13.0 INTERFACING

The proper coordination & execution of all interfacing civil works activities like fixing of conduits in roofs/walls/floors, fixing of foundation bolts, fixing of lighting fixtures, fixing of supports/embedment, provision of cut outs etc. shall be the sole responsibility of the Contractor. He shall plan all such activities in advance and execute in such a manner that interfacing activities do not become bottlenecks and dismantling, breakage etc. is reduced to minimum.

14.0 STATUTORY RULES

- 14.1 Contractor shall comply with all the applicable statutory rules pertaining to factories act (as applicable for the State). Fire Safety Rules of Tariff Advisory Committee. Water Act for pollution control etc.
- 14.2 Statutory clearance and norms of State Pollution Control Board shall be followed as per Water Act for effluent quality from plant.

- 14.3 Requirement of sulphate resistant cement (SRC) for sub structural works shall be decided in accordance with the Indian Standards based on the findings of the detailed soil investigation.
- 14.4 All building/construction materials shall conform to the best quality specified in CPWD specifications if not otherwise mentioned in this specification.
- 14.5 All tests as required in the standard field quality plans have to be carried out.

POWERGRID CORPORATION OF INDIA LIMITED
(Quality Assurance & Inspection Deptt.)

**STANDARD FIELD QUALITY PLAN
FOR SWITCHYARD CIVIL WORKS**

Section : FOUNDATION MATERIALS

Sl. No.	Component/Operation & Description of Test	Sampling Plan with basis	Ref. Document & acceptance norm	Testing Agency	Remarks	Check
1.	CHECKING OF FOUNDATION MATERIALS					
A)	CEMENT					
i)	Fineness	One sample per lot of 100 MT or part thereof from each source for MTCs and one sample per lot of 200 MT or part thereof from each source for site testing	IS:456, IS:269 IS:8112, IS:12269 IS:1489 & POWERGRID specification	Manufacturer/ POWERGRID approved lab	Review of manufacturers test certificates (MTCs) and laboratory test results by POWERGRID	B
ii)	Compressive Strength					
iii)	Initial & final setting time					
iv)	Soundness					
v)	Heat of Hydration for low heat cement (Not applicable for OPC & PPC)					
vi)	Chemical Composition of Cement	One sample per lot of 100 MT or part thereof from each source for MTCs	IS:456, IS:269 IS:8112, IS:12269 IS:1489 & POWERGRID specification	Manufacturer	Review of manufacturers test certificates by POWERGRID	B
B)	COARSE AGGREGATES					
i)	Determination of Partical size (Sieve Analysis)	One sample per lot of 100 cubic meter or part thereof from each source for each size	IS:383, IS:2386 and POWERGRID specification	POWERGRID approved lab. However, Moisture content test for design mix concrete shall be done on all days of concreting at site.	Each source to be approved by POWERGRID Review and acceptance of test result by POWERGRID.	B
ii)	Flakiness Index					
iii)	Crushing Value					
iv)	Specific Gravity*					
v)	Bulk Density*					
vi)	Absorption Value*					
vii)	Moisture Content*					
viii)	Soundness of Aggregate**					
ix)	Presence of deleterious materials					
	* Applicable Design concretes only	** Applicable to concrete work subject to frost action				

POWERGRID CORPORATION OF INDIA LIMITED
(Quality Assurance & Inspection Deptt.)

C)	FINE AGGREGATE					
i)	Gradation/Determination of Particle size (Sieve Analysis)	One sample per lot of 100 cubic meter or part thereof from each source	IS:383,IS:2386,IS:456 and POWERGRID specification	POWERGRID approved lab. However Moisture content test for design mix concrete shall be done on all days of concreting at site.	Each source to be approved by POWERGRID Review and acceptance of test result by POWERGRID.	B
ii)	Specific Gravity and density					
iii)	Moisture content					
iv)	Absorption Value					
v)	Bulking					
vi)	Silt Content Test					
vii)	Presence of deleterious materials					
D)	BRICKS					
i)	Dimensional tolerance	As per enclosed Annexure-II	CPWD & POWERGRID specification	POWERGRID approved Lab.	Approved by POWERGRID	B
ii)	Compressible Strength					
iii)	Water Absorption					
iv)	Efflorescence					
E)	WATER					
i)	Cleanliness (Visual Check)	Random	IS:456, IS:3025 and POWERGRID specification. The water used for mixing concrete shall be fresh, clean and free from oil, acids and alkalies, organic materials, or other deleterious materials	Contractor	Each source to be approved by POWERGRID	B
ii)	Chemical and physical properties of water for checking its suitability for construction purposes	One sample per source	IS:456, IS:3025 and POWERGRID specification	Contractor/ POWERGRID Approved Lab	Approved by POWERGRID	B
	*Applicable to design mix concretes only					

POWERGRID CORPORATION OF INDIA LIMITED
(Quality Assurance & Inspection Deptt.)

Sl. No.	Component/Operation & Description of Test	Sampling Plan with basis	Ref. Document & acceptance norm	Testing Agency	Remarks	Check
1.	REINFORCEMENT STEEL					
i)	Identification & size	Random	IS:432, IS:1139, IS:1786 & POWER GRID specification	Contractor	Approved by POWERGRID	B
ii)	Chemical Analysis Test	One sample per heat	IS:432, IS:1139, IS:1786 POWERGRID specification	Manufacturer	Review of manufacturers test certificates by POWERGRID	B
iii) iv) v)	Tensile Test Yield stress/proof stress Percentage Elongation	One sample per lot of 40 MT or part thereof for each size of steel conforming to IS: 1139 and 5 MT or part thereof for HDS wire for each size of steel as per IS: 432. For steel as per IS:1786 under 10mm 1 sample for each 25 MT or part thereof. 20 mm-16 mm 1 sample for each 35 MT or part thereof. Over 16mm 1 sample for each 45 MT or part thereof	IS:432, IS:1139, IS:1786 POWER GRID specification	Manufacturers/ POWERGRID approved lab	Review of manufacturers test certificates as well as lab test results by POWERGRID	B
vi)	Bend/Rebend Test	One sample per lot of 20 MT or part thereof for each size of steel as per IS:432, IS:1139. For steel as per IS:1786 under 10mm-16mm 1 sample for each 25MT or part thereof 10 mm-16mm 1 sample for each 45 MT or part thereof.	IS:432, IS:1139, IS:1786 POWER GRID specification	Manufacturers/ POWERGRID	Review of manufacturers test certificates as well as lab test results by POWERGRID	B
vii)	Reverse Bend Test for HDS wire	One sample per lot of 5 MT or part thereof for each size	IS:432 POWER GRID specification	Manufacturer/ POWERGRID approved lab	Review of manufacturers test certificates as well as lab test result by POWERGRID	B

POWERGRID CORPORATION OF INDIA LIMITED
(Quality Assurance & Inspection Deptt.)

Section : FOUNDATION

Sl. No.	Component/Operation & Description of Test	Sampling Plan with basis	Ref. Document & acceptance norm	Testing Agency	Remarks	Check
C.	STRUCTURAL STEEL USED IN CABLE TRENCHES & FOUNDATIONS					
i)	Dimensional Check	Random	POWERGRID Specification & approved drawing	Contractor	Checklist to be prepared and signed jointly	B
ii)	Visual Check for damages, rusting, Pitting etc.	100%	POWERGRID Specification & approved drawing	Contractor	Checklist to be prepared and signed jointly	C
iii)	Visual Check for welding, defects, primer, coating and painting/galvanizing as applicable	Random	POWERGRID specification & approved drawings	Contractor	Checklist to be prepared and signed jointly	C
iv)	Physical properties of structural steel	1 sample per lot of 40 MT or part thereof for tensile tests and 1 sample per lot of 20 MT or part thereof for bend test for each size.	IS:2062, POWERGRID specification & approved drawings	Manufacturer/ POWER GRID Approved lab	Review of Mfgs. Test certificates as well as lab test results by POWERGRID	B

POWERGRID CORPORATION OF INDIA LIMITED
(Quality Assurance & Inspection Deptt.)

Sl. No.	Component/Operation & Description of Test	Sampling Plan with basis	Ref. Document & acceptance norm	Testing Agency	Remarks	Check
2.	GANTRY/EQUIPMENT FOUNDATION/CABLE TRENCH					
A.	BEFORE EXCAVATION					
i)	Checking of pegs condition as per line and alignment	100% on each location	IS:4091, IS:3764 & POWERGRID approved drawings/specification	Contractor	Approval by POWERGRID	C
ii)	Checking of pit making as per drawing & RL	100% on each location	IS:4091, IS:3764 & POWERGRID approved drawings/specification	Contractor	Approval by POWERGRID	C
B.	EXCAVATION					
i)	Dimensional conformity	Each location	IS:4091, IS:3764 & POWERGRID approved drawings/specification	Contractor	Approval by POWERGRID (JMC/MB)	B
ii)	Verticality/slopes & Squareness of each pit	Each location	IS:4091, IS:3764 & POWERGRID approved drawings/specification	Contractor	Checklist to be prepared and signed jointly	B
iii)	Verification of classification of foundation wherever applicable	Each location	IS:4091, IS:3764 & POWERGRID approved drawings/specification	Joint inspection by POWER GRID and contractor	Approval by POWERGRID	B
C.	FOUNDATION BOLTS/MATALLIC INSERTS					
i)	Check for proper	100%	POWERGRID	Contractor	Checklist to be	C

POWERGRID CORPORATION OF INDIA LIMITED
(Quality Assurance & Inspection Deptt.)

	identification foundation bolts w.r.t type of foundation		specification & approved drgs.		prepared and signed jointly	
ii)	Visual check for mechanical damage and galvanising/ painting if applicable for metallic insert	100%	POWERGRID specification & approved drgs.	Contractor	Checklist to be prepared and signed jointly	C
iii)	Alignment & Level	100%	POWERGRID specification & approved drgs.	Contractor	Checklist to be prepared and signed jointly	B
iv)	Grouting/Underpinning of foundation base plate	100%	POWERGRID specification & approved drgs.	Contractor	Checklist to be prepared and signed jointly	C
D.	P.C.C. Padding	For all locations	IS:456 and POWERGRID approved foundation drawings & specification	Joint inspection by POWER GRID and contractor	Approval by POWERGRID	B
E.	SHUTTERING(Form work)					
i)	Check for materials, breakage or damage	100%	IS:456, POWERGRID specification/ approved drawings	Joint inspection by POWER GRID and contractor	Approval by POWERGRID	C
ii)	Check for plumb, alignment parallelism, squareness and equidistance from stub	100% casting	IS:456, POWERGRID specification/ approved drawings	Joint inspection by POWER GRID and contractor	Approval by POWERGRID	B
iii)	Dimensional check	100% before casting	IS:456, POWERGRID specification/ approved drawings	Joint inspection by POWER GRID and contractor	Approval by POWERGRID	B
iv)	Check for level & height	100% before casting	POWERGRID specification/ approved drawings	Joint inspection by POWER GRID and contractor	Approval by POWERGRID	B
v)	Check for rigidity of	100%	POWERGRID	Joint	Approval by	B

POWERGRID CORPORATION OF INDIA LIMITED
(Quality Assurance & Inspection Deptt.)

	frame/tightness		specification/ approved drawings	inspection by POWER GRID and contractor	POWERGRID	
vi)	Cleaning and oiling	100%	POWERGRID specification/ approved drawings	Joint inspection by POWER GRID and contractor	Approval by POWERGRID	B
vii)	Diagonal bracing if required as per drawings/site conditions	100%	POWERGRID specification/ approved drawings	Joint inspection by POWER GRID and contractor	Approval by POWERGRID	C
viii)	Checking of joints to avoid undue loss of cement slurry	100%	POWERGRID specification/ approved drawings	Joint inspection by POWER GRID and contractor	Approval by POWERGRID	C
E.	PLACEMENT OF REINFORCEMENT STEEL					
i)	Check the steel bars for rust, cracks, surface flaws, laminates etc. (Visual check)	100%	IS:456 and POWERGRID specification/ approved drawings	Joint inspection by POWER GRID and contractor	Approval by POWERGRID	C
ii)	Check as per the bar bending schedule before placement of concrete	For all locations	IS:456,IS:2502 and POWERGRID specification/ approved drawings	Joint inspection by POWER GRID and contractor	Approval by POWERGRID (Pour Card)	B
iii)	Check cutting tolerance for bars as per check list/drawings. Check whether all the bent bars and lap lengths are as per approved bar bending schedule	For all locations	IS:456,IS:2502 and POWERGRID specification/ approved drawings	Joint inspection by POWER GRID and contractor	Approval by POWERGRID (Pour Card)	B
iv)	Check whether all joints & crossing of bars are tied properly	100%	IS:456 and POWERGRID specification/ approved drawings	Joint inspection by POWER GRID and contractor	Approval by POWERGRID	C

POWERGRID CORPORATION OF INDIA LIMITED
(Quality Assurance & Inspection Deptt.)

	with right gauge & annealed wire as per specification		approved drawings	GRID and contractor		
v)	Check for proper cover distance spacing of bars, spacers, & chairs after the reinforcement cage has been put inside the formwork	100%	IS:456 and POWERGRID specification/ approved drawings	Joint inspection by POWER GRID and contractor	Approval by POWERGRID	C
vi)	Check whether lapping of bars are tied properly with right gauge and annealed wire as per specification	100%	IS:456 and POWERGRID specification/ approved drawings	Joint inspection by POWER GRID and contractor	Approval by POWERGRID	B
G.	PILE FOUNDATION (Additional Tests)					
i)	Check of centre line of pile group	Each pile group	IS:2911 & POWERGRID approved pile foundation drawings/specification	Joint inspection by POWER GRID and contractor	Checklist to be prepared and signed jointly	B
ii)	Check pile location	Each pile	IS:2911 & POWERGRID approved pile foundation drawings/specification	Joint inspection by POWER GRID and contractor	Checklist to be prepared and signed jointly	B
iii)	Temporary casing tube & permanent liner also check thickness of liner material (if applicable)	Each pile	IS:2911 & POWERGRID approved pile foundation drawings/specification	Joint inspection by POWER GRID and contractor	Verticality of the tube to be checked	B
iv)	Bentonite slurry (if applicable)	Each pile	IS:2911 & POWERGRID approved pile foundation drawings/specification	Joint inspection by POWER GRID and contractor	Records to be kept by POWERGRID for specific gravity of slurry	B
v)	Pile depth, level, size	Each pile	IS:2911 &	Joint	Approved by	B

POWERGRID CORPORATION OF INDIA LIMITED
(Quality Assurance & Inspection Deptt.)

	and alignment		POWERGRID approved pile foundation drawings/specification	inspection by POWER GRID and contractor	POWERGRID	
vi)	Chipping of pile head	Each pile	IS:2911 & POWERGRID approved pile foundation drawings/specification	Joint inspection by POWER GRID and contractor	Before concreting pile cap, pile head to be chipped off for concreting	B
vii)	Standard Penetrator Test	As per Powergrid BOQ/Specification	IS:2911 & POWERGRID approved pile foundation drawings/specification	Joint inspection by POWER GRID and contractor	Records to be kept by POWERGRID	B
viii)	Pile load testing	As per Powergrid BOQ/Specification IS:2911	IS:2911 & POWERGRID approved pile foundation drawings/specification	Joint inspection by POWER GRID and contractor	Records to be kept by POWERGRID Approval by POWERGRID	B
ix)	Anchor bolts if applicable					
a)	Level, centre to centre distance of bolts	100% on each location	POWERGRID approved pile foundation drawings/specification	Joint inspection by POWER GRID and contractor	Checklist to be prepared and signed jointly	B
b)	Visual check for galvanising	100% on each location	POWERGRID approved pile foundation drawings/specification	Joint inspection by POWER GRID and contractor	Checklist to be prepared and signed jointly	B
3.	CONCRETING					
A)	APPROVAL OF MIX DESIGN	Each Mix.	IS:456 & POWERGRID approved drawings and specifications	POWER GRID Approved by lab	Approval by POWERGRID	A
B)	BATCHING,MIX-	100%	IS:456 &	Joint	Approval by	B

POWERGRID CORPORATION OF INDIA LIMITED
(Quality Assurance & Inspection Deptt.)

	ING & PLACING OF CONCRETE AND COMPACTING		POWERGRID approved drawings and specifications	inspection by POWER GRID and contractor	POWERGRID	
C)	FIXING OF CHIMNEY COLUMN Check for Width/length squareness, parallelism & equidistance from stub	100%	IS:456 & POWERGRID approved drawings and specifications	Joint inspection by POWER GRID and contractor	Approval by POWERGRID	C
D)	PLACING CONCRETE, AND COMPACTING	100%	IS:456 & POWERGRID approved drawings and specifications	Joint inspection by POWER GRID and contractor	Min. gap between boxes and reinforcement bars should be maintained Approval by POWERGRID	B
E)	CONCRETE TESTING					
i)	Slump test	One sample per foundation	IS:456,IS:516, IS:1199 and POWERGRID Specification	Contractor	Approval by POWERGRID	B
ii)	Check for quantities for cement, fine aggregate, coarse aggregate and water while batching	100% on all locations	IS:456,IS:516, IS:1199 and POWERGRID Specification	Contractor	Checklist to be prepared and signed jointly	B

POWERGRID CORPORATION OF INDIA LIMITED
(Quality Assurance & Inspection Deptt.)

Sl. No.	Component/Operation & Description of Test	Sampling Plan with basis	Ref. Document & acceptance norm	Testing Agency	Remarks	Check
F)	CONCRETE CUBE TESTING					
i)	Compressive Strength	One sample for every 20 Cum of concreting or part thereof for each days concreting (one sample consists of min. 3 test cubes for 28 days strength).	IS:1199,IS:456, IS:516 and POWERGRID Specification	POWERGRID Approved lab	Approval by POWERGRID Cubes must be tested within a week after 28 days curing period and test results should be approved.	A
G)	CHECK FINISHING, DIMENSIONAL CONFORMITY AND WORKMANSHIP BEFORE & AFTER BOX REMOVAL	100%	IS:456,IS:516, IS:1199 and POWERGRID Specification	Contractor	Approval by POWERGRID	B
4.	BACKFILLING					
i)	Check for thickness of Layer & watering	100%	POWERGRID Specification and approved drawings	Contractor	Approval by POWERGRID	C
ii)	Visual check for correction/ramming	100%	POWERGRID Specification and approved drawings	Contractor	Approval by POWERGRID	C
iii)	Compaction test (Percentage of max. dry density)	Gantry Foundation-2 samples for each pit. Equipment	POWERGRID specification	POWERGRID approved lab	Review of lab test results by POWERGRID Elevation for testing to be	B

POWERGRID CORPORATION OF INDIA LIMITED
(Quality Assurance & Inspection Deptt.)

		and other foundation- 20% at random			decided by POWERGRID	
5.	BRICK-WORK					
i)	Mortar mix/proportion	Random	IS:2250, POWERGRID Specification & CPWD Specification	Contractor	Approval by POWERGRID	B
ii)	Plumb & Alignment	Random	POWERGRID Specification & CPWD Specification	Contractor	Approval by POWERGRID	B
iii)	Joints	Random	POWERGRID Specification & CPWD Specification	Contractor	Approval by POWERGRID	B
6.	PLASTERING					
i)	Plastering thickness and evenness	Random	POWERGRID Specification & CPWD Specification	Contractor	Approval by POWERGRID	B
ii)	Mortar mix proportion	Random	POWERGRID Specification & CPWD Specification	Contractor	Approval by POWERGRID	B
7.	CURING FOR CONCRETE, MASONRY, PLASTERING ETC.	100% on all location	IS:5613 & POWERGRID Specification	Contractor	Approval by POWERGRID	C
8.	SWITCH YARD EARTHING					
i)	Check for dimension of earth mat rod	Random	POWERGRID Specification & drawings	Contractor	Approval by POWERGRID	B
ii)	Depth of excavation	Random	POWERGRID Specification & drawings	Contractor	Approval by POWERGRID	C
iii)	Check for weld joints and anti corrosive treatment	Random	POWERGRID Specification & drawings	Contractor	Approval by POWERGRID	B
iv)	Backfilling	100%	POWERGRID Specification & drawings	Contractor	Approval by POWERGRID	C
9.	SITE SURFACING					
i)	Levelling	100%	POWERGRID Specification and approved drawings	Contractor	Checklist to be prepared and signed jointly	C

POWERGRID CORPORATION OF INDIA LIMITED
(Quality Assurance & Inspection Deptt.)

ii) a)	Soil Sterilisation Spraying of chemicals	100%	POWERGRID Specification and Manufacturers recommendations	Con tractor	Checklist to be prepared and signed jointly	B
iii)	Grading of 20/40mm Stone	1 sample per lot of 500 Cubic Metre or part thereof from each source for each size	IS: 383, IS: 2386 and POWERGRID Specification. The grading shall be as per single sized nominal size	Contractor/ POWERGRID Approved lab	Each source to be approved by POWERGRID Review and acceptance of test results by POWERGRID	B
iv)	Compacted thickness of 20/40 mm stone layers as applicable	Random	POWERGRID Specification and specification drawings	Contractor	Checklist to be prepared and signed jointly	B

Section: GENERAL GUIDELINES FOR IMPLEMENTATION

1. Details of categories of check codes A,B & C including accepting and deviation dispositioning authorities are indicated at Annexure-I.
2. POWERGRID specification shall mean POWERGRID technical specification, approved drawings data sheets and LOA provisions applicable for the specific contract.
3. Acceptance criteria and permissible limits for certain tests are indicated at Annexure-II. For balance tests, site to verify the same with respect to POWERGRID specification, relevant Indian Standards and/or prevalent code of practice.
4. It is clarified that the tests indicated at column 2 of this FQP i.e. against column “Component operation & Description of Test”, are only generally required to be conducted. However, POWERGRID reserves the right to carry-out any additional tests at any stage if the situation so warrants.
5. POWERGRID site representative shall witness all the tests conducted by the contractor as mentioned in the FQP. However, in case of tests conducted in the POWERGRID approved lab, it is preferred to witness the tests in the lab itself, if possible.
6. Head of GHQ shall approve testing laboratory before accepting the test results from the lab.
7. Head of GHQ shall approve the sources for cement , coarse aggregate, fine aggregate & water before actual utilization.
8. All the testing & measuring equipments used by the contractor for testing are required to be calibrated. A copy of valid calibration report shall be retained by POWERGRID as records.
9. Classification of foundations shall be approved by POWERGRID based on the Joint Inspection Report & soil investigation reports.
10. Curing of concrete work should be continued for minimum period of 10 days.

POWERGRID CORPORATION OF INDIA LIMITED
(Quality Assurance & Inspection Deptt.)

11. ZONE-IV FINE AGGREGATE

11.1 Zone-IV fine aggregate shall be used for nominal mix. Reinforced cement concreting work.

11.2 Zone-IV fine aggregate shall be avoided for design mix reinforced cement concreting work unless tests have been done to ascertain the suitability of proposed with the prior approval POWERGRID site.

12. Bricks should be free from cracks, flaws and modules of free lime. They should have smooth rectangular faces with sharp corners and should be uniform in colour.

13. CEMENT

13.1 In case of cement is in the scope of the contractor, the same shall be procured from sources approved by POWERGRID site and got tested on sample basis for specified acceptance tests as specified in the FQP at a reputed Third Party Lab approved by POWERGRID site.

13.2 The samples of cement for site testing shall be taken within three weeks of the delivery and all the tests shall be commenced within one week of sampling. If the cement remains in store for a period of more than six months. All the site tests are required to be repeated before usage.

14. REINFORCEMENT STEEL & STRUCTURAL STEEL USED IN CABLE TRENCHES & FOUNDATIONS

14.1 In case supply of steel is in the scope of the contractor, the same shall be procured from the main producers i.e. SAIL, TISCO, IISCO or Rashtriya Ispat Nigam or the rerollers approved by main producers. The steel shall be got tested at site on sample basis for specified acceptance tests as specified in this FQP at a reputed Third Party Lab approved by POWERGRID site.

14.2 The results of the testing of cement and reinforcement steel referred in 13.1 and 14.1 above shall be got approved from POWERGRID site before cement and reinforcement steel are put to use. However, in exceptional cases due to exigencies of work. POWERGRID site may authorize the contractor to use Cement and Reinforcement Steel even before the test results are received. However, in all such cases, if the test results subsequently received are found to be not complying with the specified acceptance criteria, the contractor shall have to dismantle and recast all such foundations cast with such non-conforming materials at his own cost. Confirmation to this effect shall be obtained from the contractor by the Project authorities beforehand in all such cases.

15. The contractor shall submit welding procedure specification (WPS) including the type of electrode used for approval of POWERGRID site before starting the welding work.

16. Approval/acceptance of individual test results by POWERGRID in the course of execution of contract will not relieve the contractor of his contractual obligations and responsibilities, nor does it limit the Owner's right under the contract.

17. In case, requirement of special items like Super Sulphated Cement, Corrosive Resistant Reinforcement Steel (CRRS) etc. arise due to site conditions, the specific approval of POWERGRID may be obtained before using the same and all the tests as per relevant standards shall be carried out.

18. All the materials shall be stored by the contractor in a manner affording convenient access for identifications and inspection at all times. Storage of material shall be in accordance with IS: 4032 (Latest Edition).

POWERGRID CORPORATION OF INDIA LIMITED
(Quality Assurance & Inspection Deptt.)

ANNEXURE-I

PAGE 1 OF 1

**ACCEPTING AND DEVIATION DISPOSITIONG AUTHORITIES FOR DIFFERENT
CATEGORIES OF CHECKS AS ENVISAGED IN FIELD QUALITY PLANT**

CATE GORY	TYPE OF CHECK	100% CHECKING/WITNESSING BY	COUNTER CHECK/SURVEI LLANCE CHECK BY	ACCEPTING AUTHORITY, IF TEST RESULTS ARE WITHIN PERMISSIBLE LIMITS	DEVIATION DISPOSITIONING AUTHORITY
'A'	CRITI- CAL	EXECUTING DEPTT. PLUS FQA REPRESENTATIVE GHQ	FQA REPRESENTATIVE AND RHQ/DHQ REPRESENTATIVE	HEAD OF DHQ	HEAD OF RHQ IN CONSULTATION WITH CQA, IF REQUIRED.
'B'	MAJOR	EXECUTING DEPTT.	DHQ- REPRESENTATIVE	HEAD OF GHQ	HEAD OF DHQ
'C'	MINOR	CONTRACTORS REPRESENTATIVE	EXECUTING DEPTT.	MINIMUM E4 LEVEL EXECUTING OF SUB- STATION/TL	HEAD OF GHQ

POWERGRID CORPORATION OF INDIA LIMITED
(Quality Assurance & Inspection Deptt.)

ANNEXURE-2
Page 1 of 5

**ACCEPTANCE CRITERIA AND PERMISSIBLE LIMITS FOR
FOUNDATION MATERIALS AND CONCRETE**

A) CEMENT

S. No.	Description of the tests	33 Grade OPC as per IS:269	43 Grade cement as per IS:8112	PPC as per IS:1489	Low Heat cement
1.	Fineness (min.)	225 m ² /kg	225 m ² /kg	300 m ² /kg	225 m ² /kg
2.	Compressive strength (min.) 72 ± 1 hours 168 ± 2 hours 672 ± 4 hours	160 kgf/cm ² 220 kgf/cm ² -	23 MPa 33 MPa 43 MPa	16 MPa 22 MPa 33 MPa	100 Kgf/cm ² 160 Kgf/cm ² 350 Kgf/cm ²
3.	Initial setting time (min.)	30 minutes	30 minutes.	30 minutes	30 minutes
4.	Final setting time (max.)	600 minutes	600 minutes	600 minutes.	600 minutes.
5.	Soundness (Le Chatelier Method)	Maximum 10 mm expansion	Maximum 10 mm expansion	Maximum 10 mm expansion	Maximum 10 mm expansion
6.	Heat of Hydration (max.)	-	-	-	Max. 65 cal/gm for 7 days & max. 75 cal./gm for 28 days
7.	Chemical composition	As per IS	As per IS	As per IS	As per IS

B) COARSE AGGREGATE :

(i) Sieve Analysis

IS SIEVE DESIGNATION	PERCENTAGE PASSING FOR GRADED AGGREGATE OF NOMINAL SIZE		PERCENTAGE PASSING FOR SINGLE SIZED AGGREGATE OF NOMINAL SIZE	
	40 mm	20 mm	40 mm	20 mm
63 mm	-	-	100	-
40 mm	95 to 100	100	85 – 100	100
20 mm	30 to 70	95 to 100	0 – 20	85 - 100
10 mm	10 to 35	25 to 55	0 – 5	0 - 20
4.75 mm	0 to 5	0 to 10	-	0 - 5

POWERGRID CORPORATION OF INDIA LIMITED
(Quality Assurance & Inspection Deptt.)

ANNEXURE-2
Page 2 of 5

- (ii) Flakiness Index Not to exceed 25%
- (iii) Crushing value Not to exceed 45%
- (iv) Soundness of aggregate applicable for concrete works subject to frost action Loss of weight after 5 cycle not to exceed 12% when tested with Sodium sulphate and 18% when tested with magnesium sulphate
- (v) Deleterious material Not to exceed 5% of the weight of aggregate when tested as per IS:2386 Part – II (1963)

(C) FINE AGGREGATE

- (i) Sieve Analysis Shall confirm to Zone-I, Zone-II or Zone-III

IS Sieve designation	Grading Zone-I	Percentage Grading Zone-II	Passing for Grading Zone-III	Grading Zone-IV
10 mm	100	100	100	100
4.75 mm	90 - 100	90 - 100	90 - 100	90 - 100
2.36 mm	60 - 95	75 - 100	85 - 100	95 - 100
1.18 mm	30 - 70	55 - 90	75 - 100	90 - 100
600 Micron	15 - 34	35 - 59	60 - 79	80 - 100
300 Micron	15 - 20	8 - 30	12 - 40	15 - 50
150 Micron	0 - 10	0 - 10	0 - 10	0 - 15

- (ii) For guidance of adjusting sound in mix of concrete, the following table may be used.

Moisture Content %	building % by volume
2	15
3	20
4	25
5	30

- (iii) Silt Content Test: Shall not exceed 8% when tested as per test procedure specified in appendix-D of chapter 3 of 1991-92 CPWD Specification.
- (iv) Deleterious Materials: Total deleterious material shall not be more than 5% by weight.

POWERGRID CORPORATION OF INDIA LIMITED
(Quality Assurance & Inspection Deptt.)

ANNEXURE-2
Page 3 of 5

(D) REINFORCEMENT STEEL: As per relevant Indian Standards.

(E) CONCRETE CUBE TEST

For nominal (volumetric) concrete mixes, compressive strength for 1:1½:3 (cement : sand : coarse aggregate) concrete shall be 265 kg/cm² for 28 days and for 1:2:4 nominal mix, it shall be 210Kg/cm².

(F) ACCEPTANCE CRITERIA BASED ON 28 DAYS COMPRESSIVE STRENGTH FOR NOMINAL MIX CONCRETE

- (a) The average of the strength of three specimen be accepted as the compressive strength of the concrete, provided the strength of any individual cube shall neither be less than 70% nor higher than 130% of the specified strength.
- (b) If the actual average strength of accepted sample exceeds specified strength by more than 30%, the Engineer-in-charge, if he so desires, may further investigate the matter. However, if the strength of any individual cube exceeds more than 30% of specified strength, it will be restricted to 30% only for computation of strength.
- (c) If the actual average strength of accepted sample is equal to or higher than specified strength upto 30%, then strength of the concrete shall be considered in order and the concrete shall be accepted at full rates.
- (d) If the actual average strength of accepted sample is less than specified strength but not less than 70% of the specified strength, the concrete may be accepted at reduced rate at the discretion of Engineer-in-Charge.
- (e) If the actual average strength of accepted sample is less than 70% of specified strength, the Engineer-in-Charge shall reject the defective portion of work represented by sample and nothing shall be paid for the rejected work. Remedial measures necessary to retain the structure shall be taken at the risk and cost of contract. If, however, the Engineer-in-Charge so desires, he may order additional tests to be carried out to ascertain if the structure can be retained. All the charges in connection with these additional tests shall be borne by the contractor.

(G) ACCEPTANCE CRITERIA FOR DESIGN MIX CONCRETE SHALL BE AS PER IS:456.

POWERGRID CORPORATION OF INDIA LIMITED
(Quality Assurance & Inspection Deptt.)

ANNEXURE-2
Page 4 of 5

(H) SAMPLING PLAN FOR BRICK WORK

- i) Scale of sampling and permissible number of defectives for visual and dimensional characteristics.

No. of bricks in the lot	For characteristics specified for individual bricks		For dimensional characteristics for group of 20 bricks-No. of bricks to be selected
	No. of bricks to be selected	Permissible no. of defective in the sample	
(1)	(2)	(3)	(4)
2001-10000	20	1	40
10001-35000	32	2	60
35001-50000	50	3	80

Note : In case the lot contains 2000 or less bricks the sampling shall be as per decision of the Engineer-in-Charge.

- ii) Scale of sampling for physical characteristics

Lot size	Sampling size for compressive strength water absorption and efflorescence	Permissible no of defectives for effloresnce
(1)	(2)	(3)
2001-10000	5	0
10001-35000	10	0
35001-50000	15	1

Note: In case the lot contains 2000 or less bricks, the sampling shall be as per decision of Engineer-in-Charge.

POWERGRID CORPORATION OF INDIA LIMITED
(Quality Assurance & Inspection Deptt.)

ANNEXURE-2
Page 5 of 5

(I) ACCEPTANCE CRITERIA FOR BRICK-WORK

- (i) Dimensional tolerances: The dimensions of modular bricks when tested shall be within the following limits per 20 bricks.
- Length 372 to 388 cm (380 ± 8 cm)
Width 176 to 184 cm (180 ± 4 cm)
Height 176 to 184 cm (180 ± 4 cm) for 90 mm high bricks
- (ii) In case of non-modular bricks, %age tolerance will be +/- 2% for group of 20 numbers of class 10 bricks and +/- 4% for other class of bricks.
- (iii) Compressive strength: The bricks, shall have a minimum average compressive strength as specified in POWERGRID specification. The compressive strength of any individual brick tested shall not fall below the min. average compressive strength specified for the corresponding class of brick by more than 20%. In case compressive strength of any individual brick tested exceeds the upper limit specified for the corresponding class of bricks, the same shall be limited to upper limit of the class as specified for the purpose of calculating the average compressive strength.
- (iv) Water absorption: The average water absorption of bricks shall not be more than 20% by weight.
- (v) Efflorescence: The rating of efflorescence of bricks shall not be more than moderate.

765/400kV SUBSTATION AT RAICHUR

LIST OF DRAWINGS

S. No.	DRAWING NO.	TITLE
1.	C/ENGG/CVL/SYD/GATE/02	Details of switchyard gate
2.	C/ENGG/STD/ ROAD CULVERTS-1	Detail of road culverts
3.	C/ENGG/STD/DRAIN/01	Details of drain
4.	C/ENGG/CVL/SYD/FENCE/001	Standard details for switch yard chain link fencing
5.	C/ENGG/STD/ROAD/411	Details of Concrete road (Rigid Pavement) in Switchyard Area
6.	C/ENGG/STD/ROAD/410	Details of Concrete road (Rigid Pavement) in Township Area

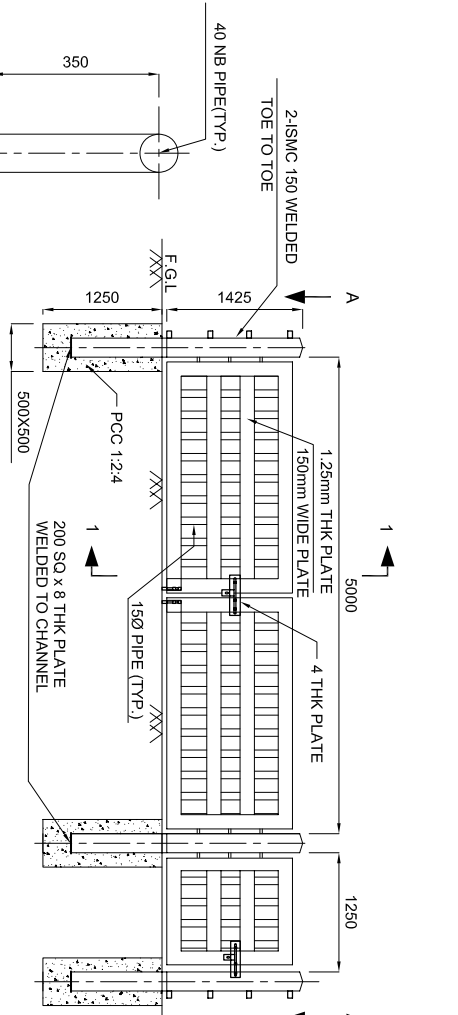

SWITCHYARD FENCING GATE DETAIL

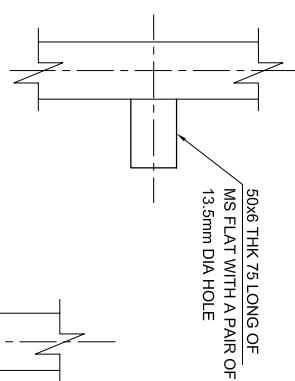

DETAIL - B

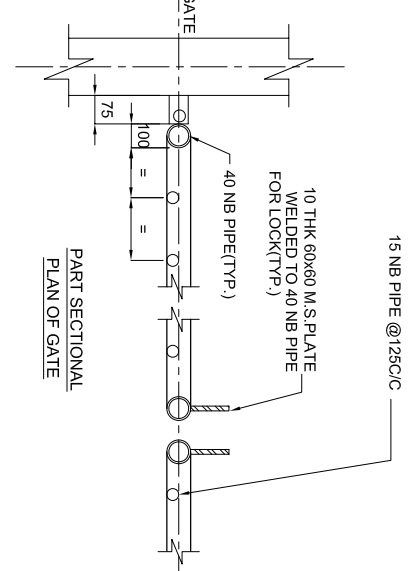

PART SECTIONAL PLAN OF GATE

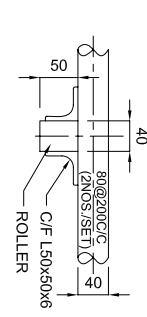

TYP DETAIL OF GATE ROLLER

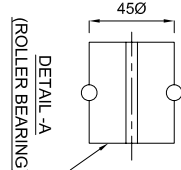

DETAIL - A (ROLLER BEARING)

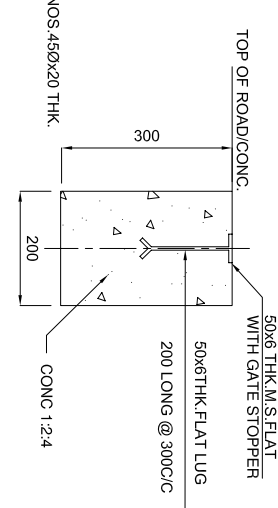

SECTION 22

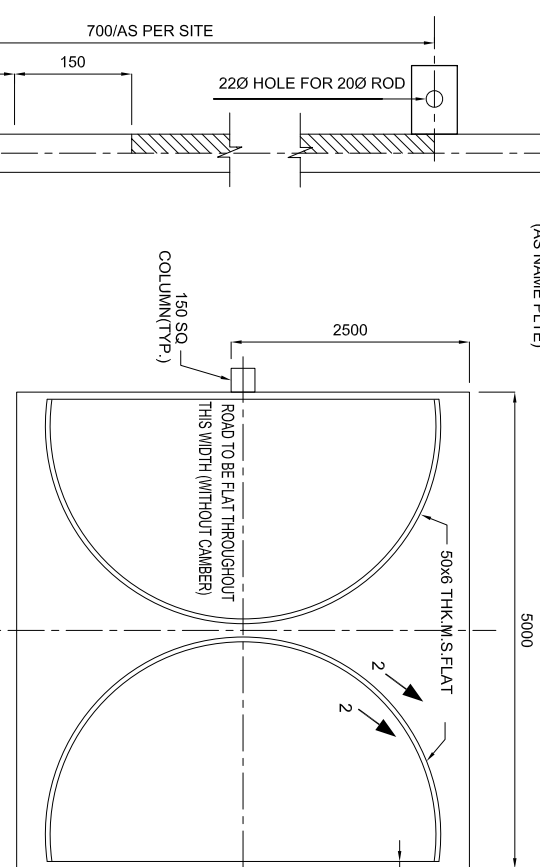

VIEW/A (OUT-SIDE)

- NOTES:
1. ALL DIMENSIONS ARE IN MM & ELEVATION ARE IN METER UNLESS NOTED OTHERWISE
 2. ALL LEAN CONC. SHALL BE PCC (1:4:8) UNLESS NOTED OTHERWISE.
 3. UNLESS NOTED OTHERWISE LAP/ANCHOR LENGTH SHALL BE 50 TIMES THE DIA OF BARS
 4. ALL STRUCTURAL STEEL CONFORM TO IS:2062 & SHALL PAINTED WITH A COAT OF APPROVED STEEL PRIMER & TWO COATS OF SYNTHETIC ENAMEL PAINT UNLESS NOTED OTHERWISE.
 5. DROP BOLTS SHOULD BO PROVIDED ON THE FAR SIDE ONLY.
 6. ALL WELDS ARE 6MM THK. FILLET WELDS UNLESS NOTED OTHERWISE.
 7. GATE & M.S. HOOKS TO BE PAINTED WITH ONE COAT APPROVED STEEL PRIMER BEFORE ERECTION & TWO COAT OF SYNTHETIC PAINTS AFTER ERECTION.
 8. STRUCTURAL PIPES SHALL BE MEDIUM TYPE CONFORMING TO IS 1161/806

RELEASED FOR TENDER & CONSTRUCTION.

PROJECT :
STANDARD DRAWING FOR
SWITCHYARD GATE

POWER GRID CORPORATION
OF INDIA LIMITED
(A Government of India Enterprise)



SECTION 1-1

APPROVED BY ED (ENGG) ON 02.05.2005 VIDE NOTE
SHEET REF. NO. C/ENGG./CIV/SID-S/S DTD 30.03.2005

ACQ/ENGG- (CIVIL)	COE/ENGG- (CIVIL)	DGM/ENGG- (CIVIL)	AGM/ENGG- (TLCIVIL)	GM/ENGG- (S/S)	ED/ENGG	DATE	SCALE M/S	DRAWING NO. C:ENGG/CVL/SYD/GATE/002	REV R-0
								DETAILS OF SWITCHYARD GATE	

TITLE :
DETAILS OF SWITCHYARD GATE

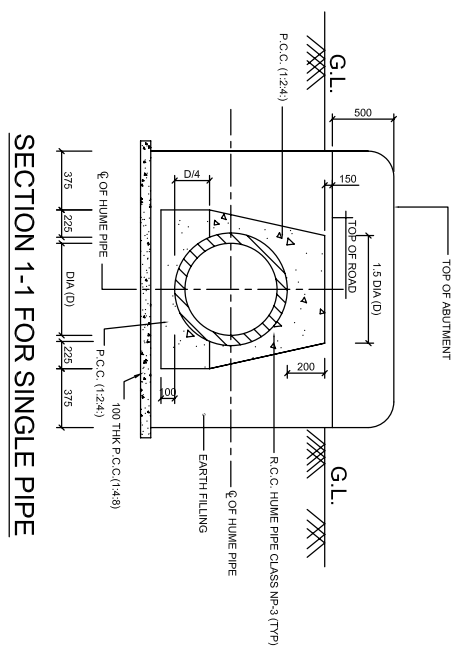

SECTION 1-1 FOR SINGLE PIPE

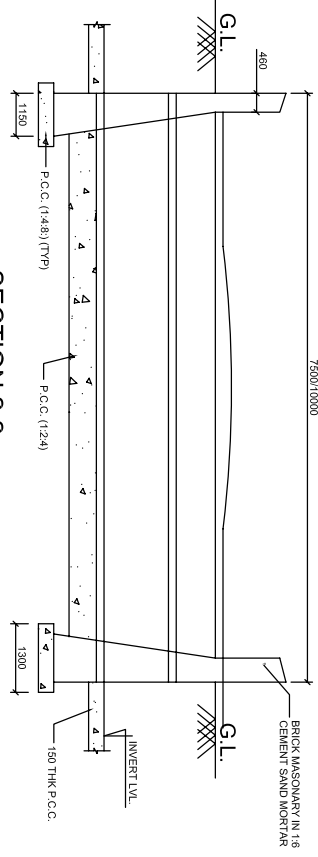

SECTION 2-2

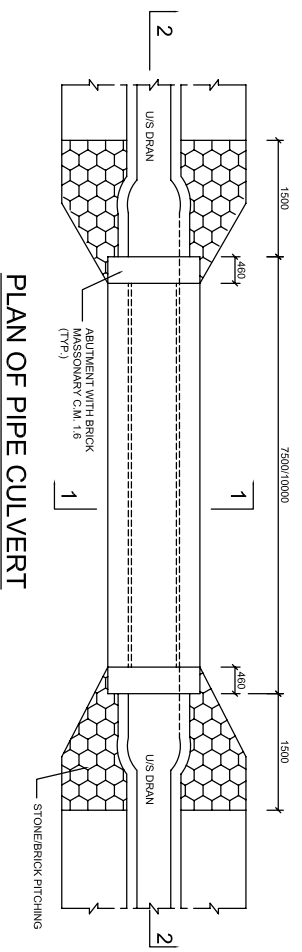

PLAN OF PIPE CULVERT

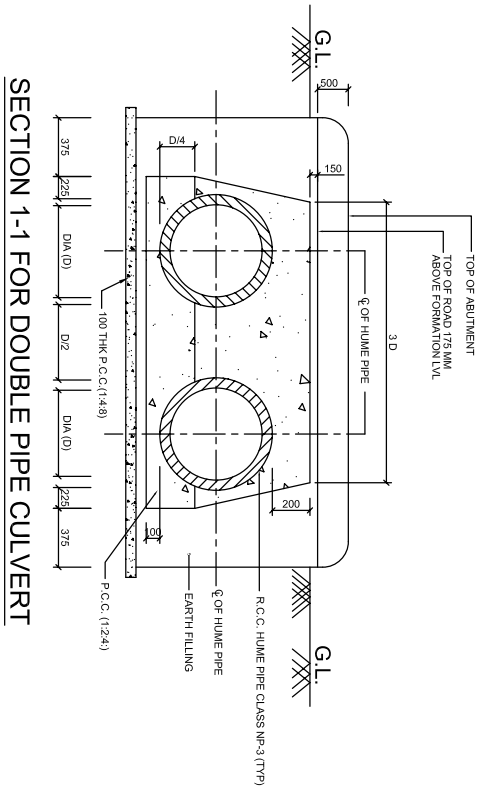

SECTION 1-1 FOR DOUBLE PIPE CULVERT

- NOTES:-**
1. ALL DIMENSIONS ARE IN MM.
 2. DO NOT SCALE THE DRG.
 3. WORK SHALL BE DONE AS PER C.P.W.D. SPECIFICATION.

APPROVED BY ED (ENCG) ON 02.05.2005, VIRE NOTE
SHEET REF. NO. C/ENCG/CV/SR/S/S DTD 30.03.2005

RELEASED FOR TENDER & CONSTRUCTION

**POWER GRID CORPORATION
OF INDIA LIMITED**
(A Government of India Enterprise)

PROJECT : **STANDARD DRAWING FOR
SWITCH YARD ROADS**

TITLE : **DETAIL OF ROAD CULVERTS**

AGENCIENG- CIVIL	COEENGG- CIVIL	OGHENGG- CIVIL	AGENCIENG- TECH(CIVIL)	GMENGG-SS (L/CIVIL)	EMENGG- (L/CIVIL)	EDENGG (DATE)	SCALE M/S	DRAWING NO. C/SRNG/STP/ROAD CULVERTS- 1	REV R-0
------------------	----------------	----------------	------------------------	---------------------	-------------------	---------------	------------------	--	----------------



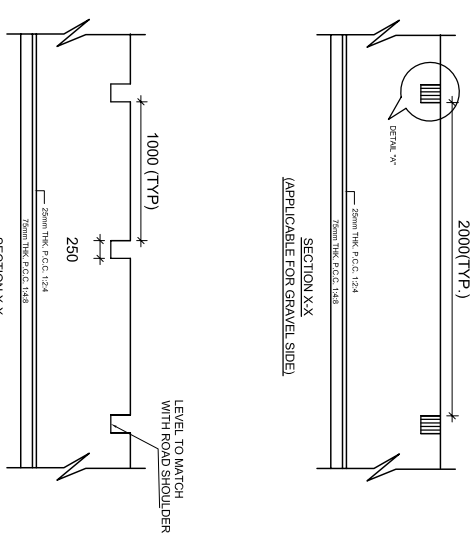
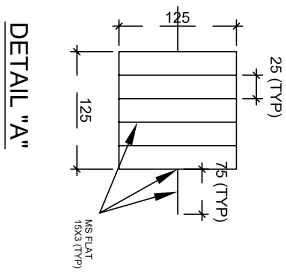
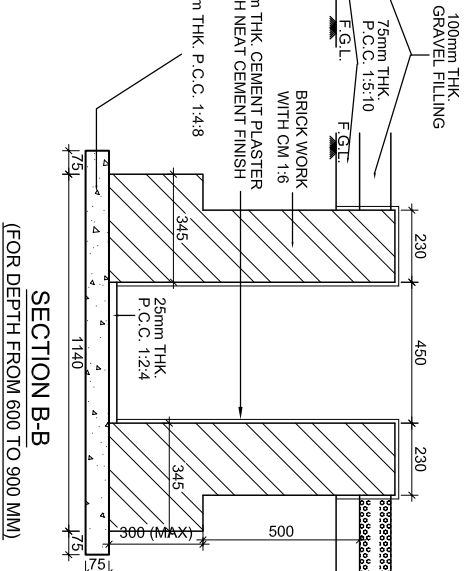
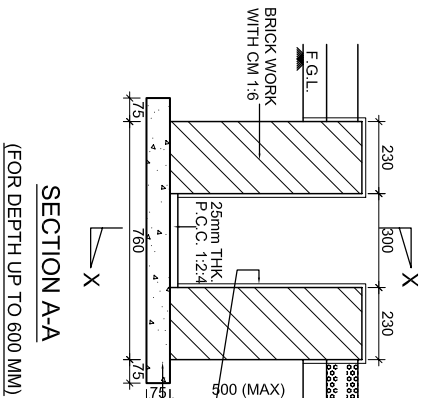

NOTES:-

1. ALL DIMENSIONS ARE IN MM. & ELEVATIONS ARE IN METRE UNLESS NOTED OTHERWISE.
2. ALL DRAINS SHALL BE GIVEN A MINIMUM SLOPE OF 1:1000 IN THE LONGITUDINAL DIRECTION
3. MINIMUM DEPTH OF DRAIN SHALL BE 300MM BELOW FGL.
4. WHERE EVER TWO SECTIONS ARE MEETING A TRANSITION ZONE SHALL BE CONSTRUCTED HAVING LENGTH 1000mm.
5. 75X75mm WEEP HOLE SHALL BE PROVIDED AT SPACING OF 1500mm HORIZONTALLY & 300mm VERTICALLY IN STAGGERED MANNER.
6. DEPTH OFF DRAIN IS TAKEN AS HEIGHT FROM TOP OF DRAIN TO INVERT OF DRAIN
7. LAYOUT OF DRAIN WILL BE ISSUED DURING EXECUTION STAGE

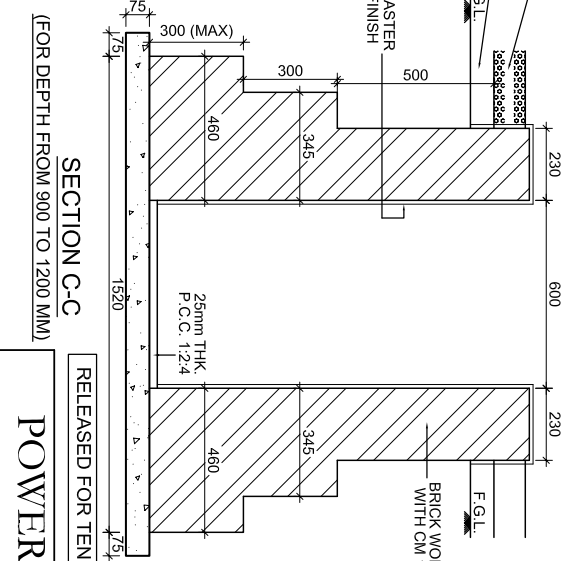
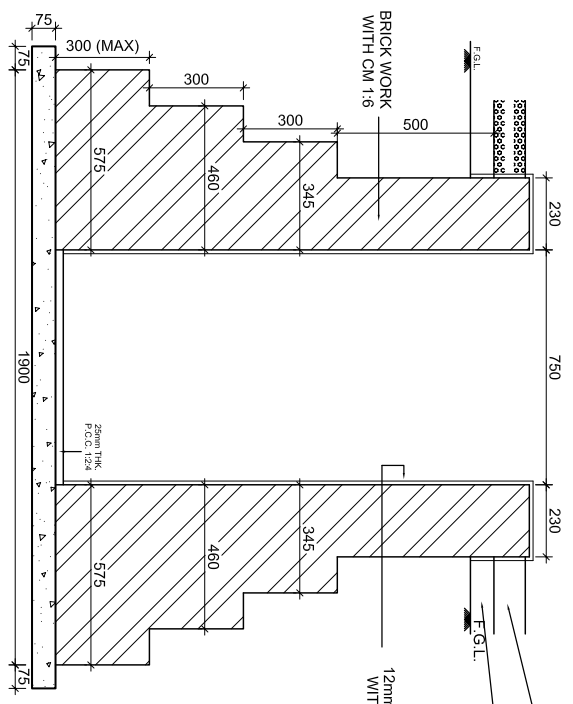

RELEASED FOR TENDER & CONSTRUCTION

POWER GRID CORPORATION OF INDIA LIMITED
(A Government of India Enterprise)



PROJECT : STANDARD SUBSTATION DRAWING

TITLE : DETAILS OF DRAIN

DRAWING NO.

C/ENGG/STD/RAIN/01

REV.

0

ACD/ENGG- CIVIL	D/ENGG- CIVIL	DGM/ENGG- CIVIL	AGM/ENGG- TLCIVIL	GM/ENGG-S/S	EM/ENGG- TLCIVIL	ED/ENGG	DATE
-----------------	---------------	-----------------	-------------------	-------------	------------------	---------	------

APPROVED BY ED (ENGG) ON 02.05.2005 VIDE NOTE
SHEET REF. NO. C/ENGG./CIV/Std-S/S DTD 30.03.2005

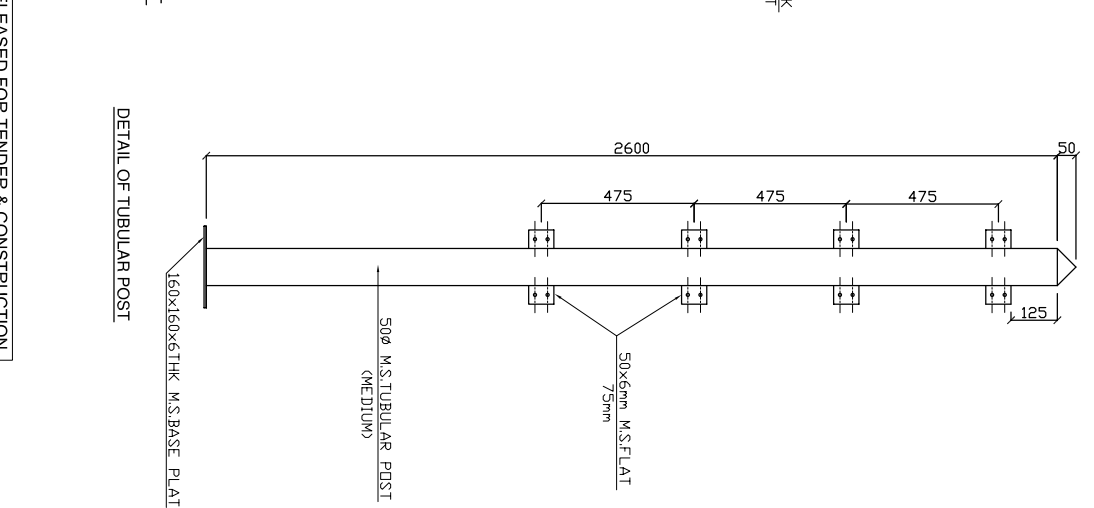
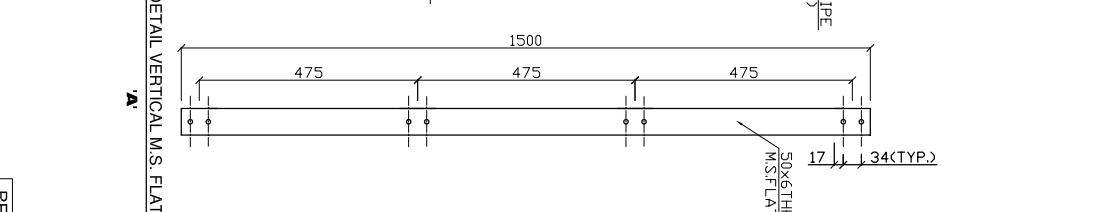
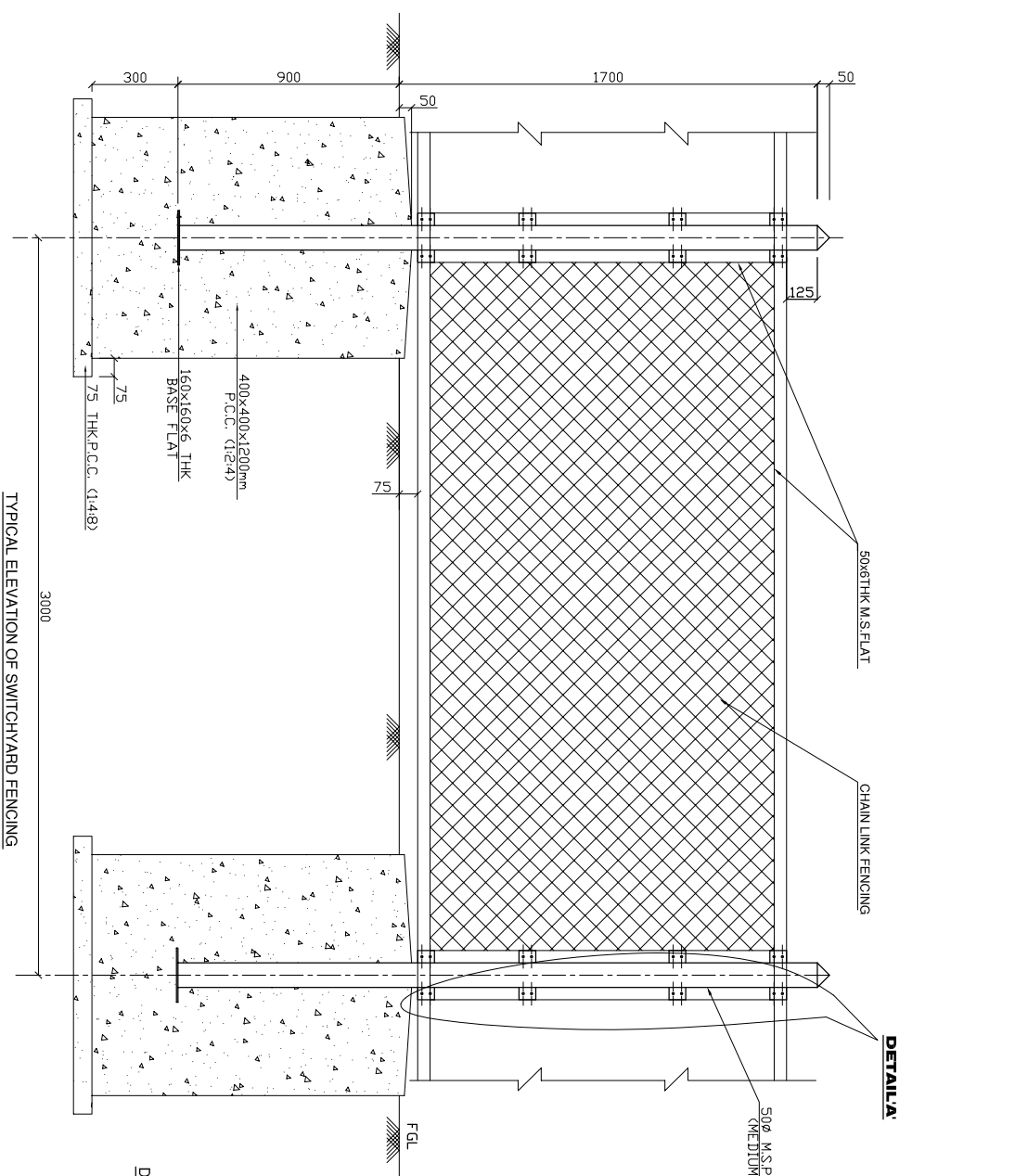

- NOTES:**
1. +000 SHALL DENOTE SWITCHYARD FINISHED FORMATION LEVEL
 2. CHAIN LINK FENCING SHALL HAVE 315 mm DIAMETER WIRE AS PER IS 2721 WITH 75x75 mm MESH SIZE AND PAINTED
 3. TUBULAR POST SHALL BE PLACED @ 3.0m CENTRE TO CENTRE AND SHALL REST IN WELL COMPACTED EARTH
 4. CORNER TUBULAR POST SHALL BE PROVIDED CLEATS IN FOUR SIDES CUTTING TO REQUIREMENT
 5. TUBES/PIPES OF POST SHALL BE GALVANIZED
 6. CONCRETE GRADE FOR P.C.C. SHALL conform IS 456. LATEST
 7. EXPOSED SURFACE OF CONCRETE PAD (P.C.C.) SHALL BE PLASTERED WITH 12mm THICK CEMENT PLASTER (1:4:8)

APPROVED BY ED (ENGG) ON 02.05.2005 VIDE NOTE
SHEET REF. NO. C/ENGG./CIV/Std-S/S DTD 30.03.2005

RELEASED FOR TENDER & CONSTRUCTION.

**POWER GRID CORPORATION
OF INDIA LIMITED**
(A Government of India Enterprise)



PROJECT :
STANDARD DRAWING FOR
FENCING

TITLE :
STANDARD DRAWING FOR SWITCH YARD
CHAIN LINK FENCING

ACQ/ENGG- CIVIL)	CDE/ENGG- CIVIL)	DGM/ENGG- CIVIL)	AGM/ENGG- TL/CIVIL)	GM/ENGG-S/S) TL/CIVIL)	ED/ENGG)	DATE	SCALE M/S	DRAWING NO.	C:ENGG/CVL/SYD/FENCE/001	REV R-0
------------------	------------------	------------------	---------------------	------------------------	----------	------	--------------	-------------	--------------------------	------------

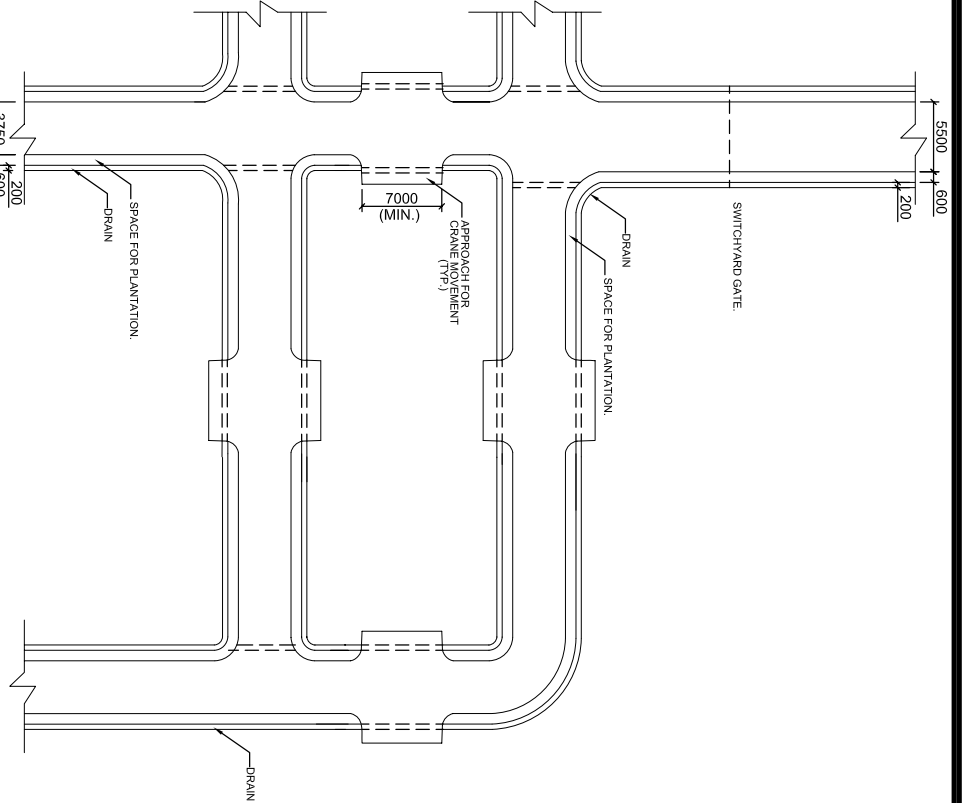
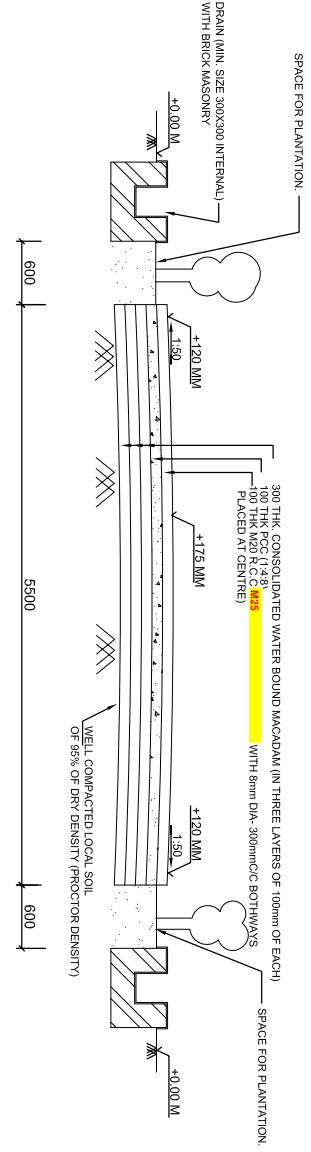
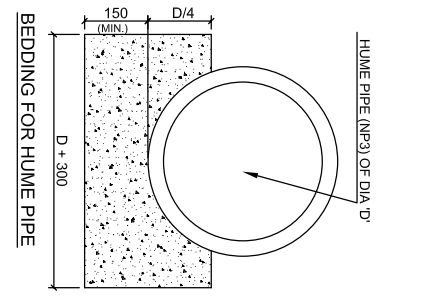
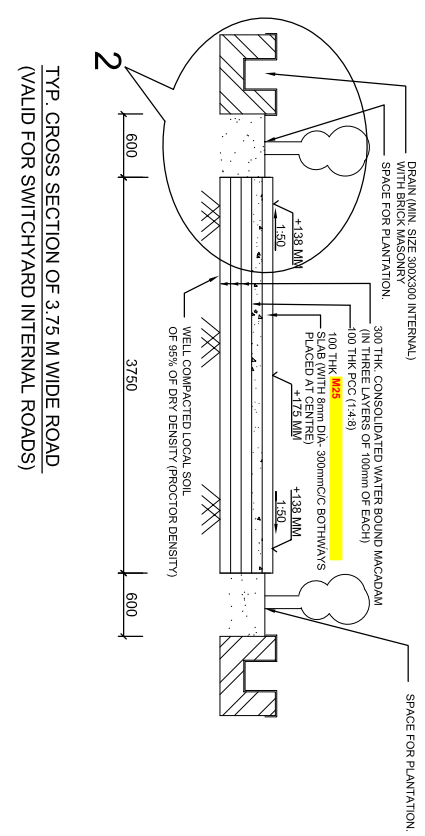

TYP. CROSS SECTION OF 3.75 M WIDE ROAD
(VALID FOR SWITCHYARD INTERNAL ROADS)

TYP. SWITCHYARD ROAD AND DRAIN LAYOUT PLAN

- NOTES:
1. ALL DIMENSIONS ARE IN MM UNLESS NOTED OTHERWISE.
 2. CAMBER OF 1.50 SHALL BE PROVIDED.
 3. EXPANSION JOINT (12 MM THICK) SHALL BE PROVIDED AT EVERY 8.0M.
 4. POLYTHENE SHEET OF 25 MICRONS SHALL BE PROVIDED BETWEEN THE PCC AND RCC SLAB (TOP SLAB)
 5. 100MM DIA. RCC HUME PIPE (NF-3) SHALL BE PLACED ACROSS THE ROAD AT EVERY 100M INTERVAL.
 6. FINISHED TOP OF ROAD CREST SHALL BE 75 MM (MIN.) ABOVE F.L.L. (SWITCHYARD FORMATION LEVEL).

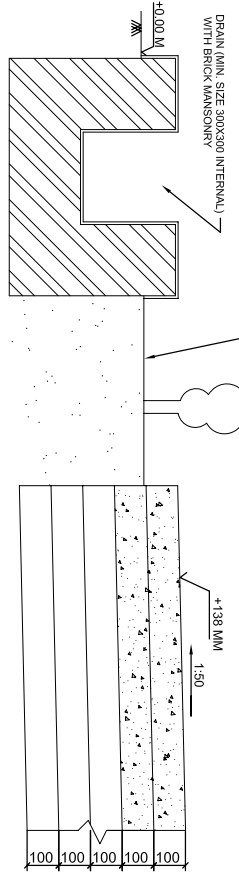

DETAIL - 2

REV.	DESCRIPTION	CIVIL.	REVD.	REVD.	ELEC.	APPD.	DATE.

PROJECT :	765 / 400 / 220 Kv SUBSTATIONS
TITLE :	DETAIL OF CONCRETE ROAD (RIGID PAVEMENT) IN SWITCHYARD AREA
DESIGNER :	CIENGG/STD/ROAD/411
SCALE :	
REV :	0

RELEASED FOR TENDER/CONSTRUCTION

POWER GRID CORPORATION OF INDIA LIMITED
(A Government of India Enterprise)



APPROVED BY ED (ENGG) ON 02/05/2005 VIDE NOTE SHEET REF. NO. C/ENGG/CIV/STDS/STD/3003.2005

